

Revision			
Rev.	Description	Date	Approved
A-1		2018/5/9	RD

Retainer "R" / R92PS

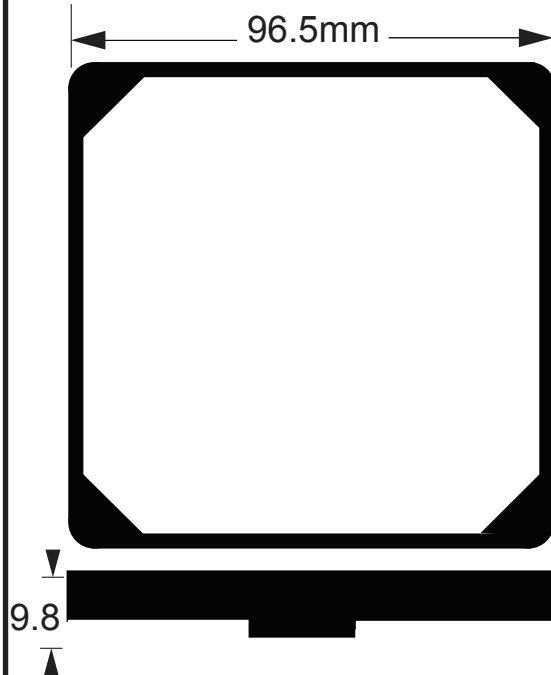

Media "S" / S92-30

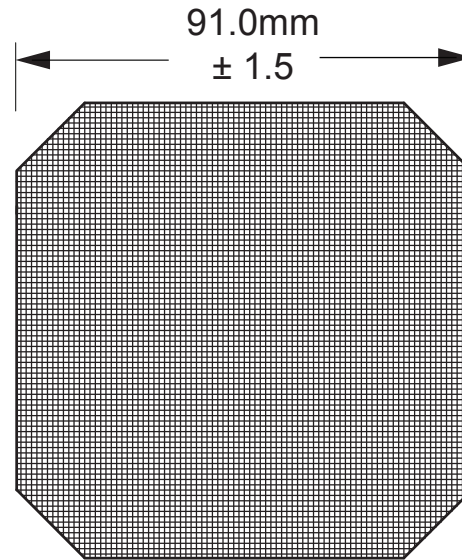

Media filtering holes(PPI)
30 PPI (30 holes per sq. inch)
 *PPI=Porous Per Inch
 Each wire diameter is 0.3mm.

Guard "G" / G92PS

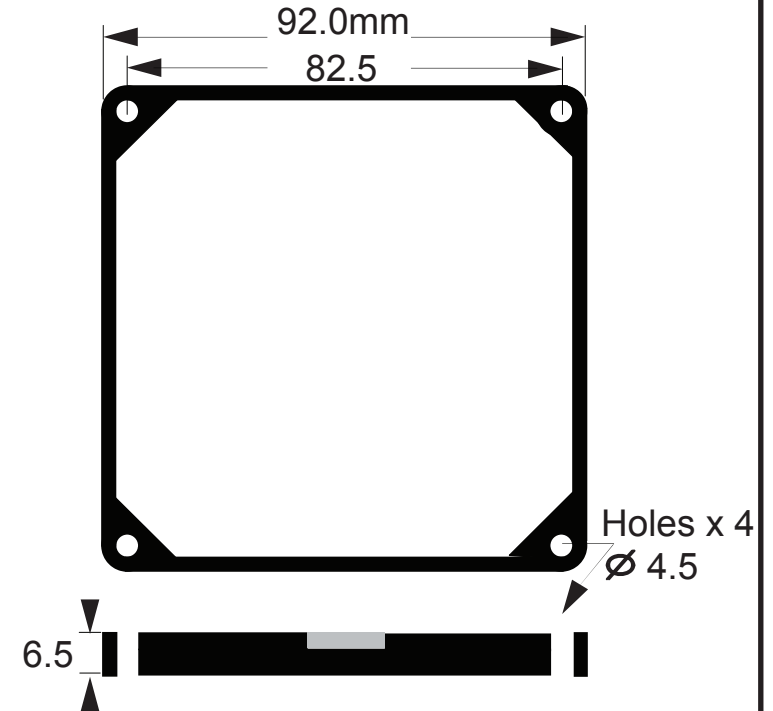

Specification / Material:

- General tolerance unless noted is $\pm 0.3\text{mm}$
- Plastic guard "G" & Retainer "R" made of plastic ABS764 glass reinforced flammability rated UL94V-0
- Media "S" is made of Stainless steel wire (304), tightly woven corrugated. Mesh 30x30 holes.
- Color: black / Weight:

 Sinwan Electric Industries Co., Ltd.	
Part Number:	GRS92-30B
Description:	(Plastic Stainless Filter Kits For 92mm (3.62") Fans)